

Nederman

IMPROVING YOUR WORKSPACE



**MFS - Modular Filter System
for capture at source**

MFS – Modular Filter System

Efficient, versatile and easy to install

The Modular Filter System simply solves the need of cleaning the air from particles, smoke, dust, gases and smells. The modular construction means that the system is suitable for both small workspaces and larger manufacturing works. By supplementing with Nederman fans, extraction arms and control boxes, you can build up a solution for every workplace.



Extensive extraction and filter know-how

Nederman is a world leader in products and systems that improves workspaces in all kinds of industries. We have more than 60 years of experience from “capturing at source”, i.e. extracting airborne contaminants such as dust, smoke, exhaust fumes and oil mist right at the point of creation. When choosing a Nederman filter you have access to this extensive know-how.

- Simple and quick installation – few parts
- Easy to expand
- Can be supplemented with fan, extraction arm and control box

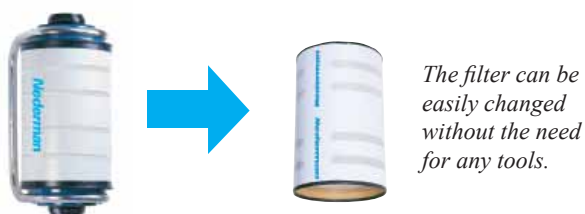

Particle filter

The particle filter for welding smoke and fine particles. The filtration efficiency is up to 99%.



Micro filter/HEPA

HEPA filter (High Efficiency Particulate Air filter) for ultra fine and contaminating particles with filtration efficiency up to 99.95%, 0,2 µm. The filter can be combined with particle and gas filters to further clean the air.*



Gas filter/Carbon

The gas filter effectively absorbs irritating smells, gases, smoke and organic solvents. Many gas filters can be used together to achieve the desired effect. The gas filter can also be combined with particle and micro filters.

*) acc. EN 1822, H13.

Installation examples

Single filter unit

The filter is easily mounted on the wall. The filter can be equipped with a fan (or connected to a ventilation duct) and a Nederman extraction arm.

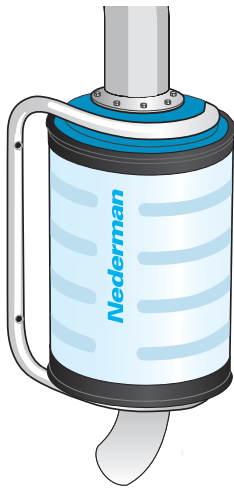

Parallel filter combination

Two filters in parallel lower the pressure drop and increase the air volume.

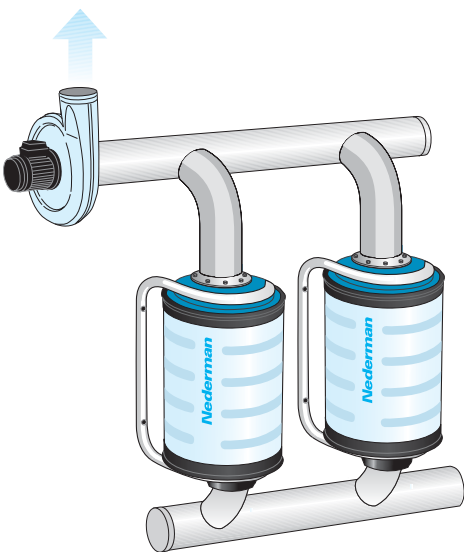

Filter combinations and silencer

Filter systems can consist of many filters combined to remove both particles and gases.

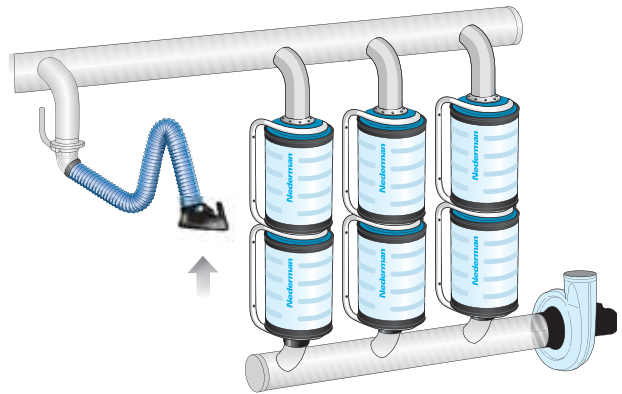

Double filter combinations with silencer/security filter

A carbon filter is fitted after the particle filter to filter particles and gases. A HEPA filter after the fan is used as a silencer and a "security filter". The clean air can re-circulate back into the premises and significant energy savings can be made. (In some countries re-circulation is not approved).

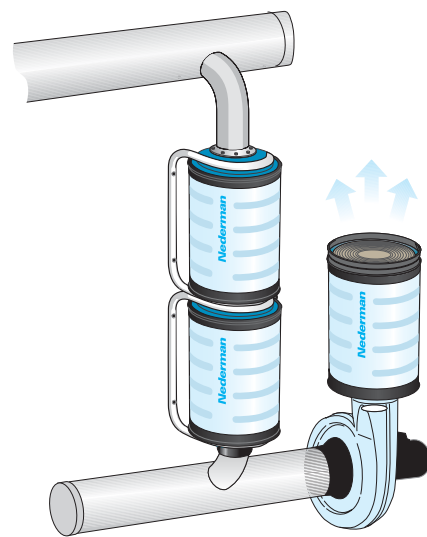

Technical information



Particle filter

For welding smoke, dust and large particles.

Part no	12600144
Filter surface	18 m ²
Filtration degree	99 %*
Weight	8.8 kg

Material

Cylinder	Cellulose paper
Filter media	Cellulose paper BIA Category M

*) acc. to EN 1822, H 13

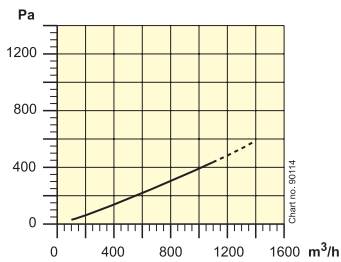

Micro filter/HEPA (H13)

For ultra fine and contaminating particles.

Part no	12600444
Filter surface	14 m ²
Filtration efficiency	99.95% *
Weight	6.4 kg

Material

Cylinder	Cellulose paper
Filter media	Micro fibreglass

*) acc. to EN 1822, H 13

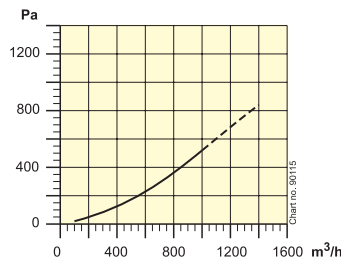

Gas filter/Carbon

Absorbs smells, gases, smoke and organic solvents (toluene and methylethylketone).

Part no	12600544
Weight total	21 kg
Weight filtration media	15 kg

Material

Cylinder	Cellulose paper
Filter media	Activated carbon

The flow of air should not exceed 500 m³/h per filter unit. The lower the flow of air, the better the filtration ability/absorption.

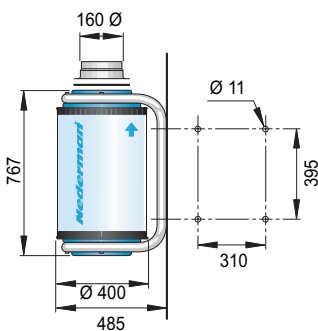
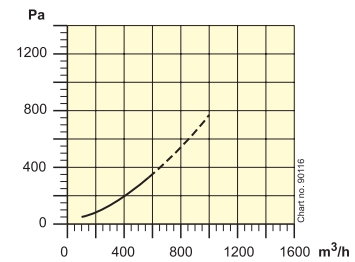

Filters without console

Particle filter:	12600711
Micro / HEPA filter:	12603361
Gas filter :	12603461

Accessories

Console: 12600644

Complementary equipment

Extraction arms: see separate brochure
Fans and control box: see separate brochure

Nederman

www.nederman.com

Nederman is represented in:

Australia, Austria, Bahrain, Belgium, Brazil, Bulgaria, Canada, China, the Czech Republic, Cyprus, Denmark, Egypt, Estonia, Finland, France, Germany, Greece, Hong Kong, Hungary, Iceland, India, Iran, Ireland, Italy, Japan, Korea, Latvia, Lithuania, Malaysia, the Netherlands, Norway, Philippines, Poland, Portugal, Romania, Russia, Saudi Arabia, Serbia & Montenegro, Singapore, Slovenia, South Africa, Spain, Sweden, Switzerland, Taiwan R.O.C., Thailand, Turkey, United Arab Emirates, United Kingdom, USA.